

# RECALL BULLETIN 09V-487

DATE: March 1, 2010  
MODEL YEAR: 2007 & 2008  
CHASSIS MODEL: UD3300 with Locally Installed DUAL STEERING  
BULLETIN NUMBER: 09V-487

FILE IN THE BRAKE SECTION OF THE TECHNICAL BULLETIN BINDER

## VOLUNTARY SAFETY RECALL CAMPAIGN NUMBER 09V-487 BRAKE APPLICATION / RELEASE TIMING CORRECTION

### MODELS AFFECTED

Specific 2007 & 2008 MY UD3300 model vehicles within the vehicle identification ranges listed below were modified for the street sweeper vocation with a locally installed dual steering system by Pioneer Drive LLC as the Intermediate Manufacture.

Listed below is the Vehicle Identification range and the total number of vehicles involved for each year model.

NUMBER	YEAR	STARTING SEQUENCE	THRU	ENDING SEQUENCE
5	2007	JNAPC80L37AE60049	—	JNAPC80L27AH60150
68	2008	JNAPC81L98AE70116	—	JNAPC81L38AE70211

### DESCRIPTION

Specific 2007 and 2008 Model Year UD3300 model vehicles modified with dual steering for street sweeper use fail to comply with the requirements of Federal Motor Vehicle Safety Standard No. 121, "Air Brake Systems". Brake Actuation and Release Timing recertification was not performed on these vehicles by the intermediate manufacturer, Pioneer Drive, LLC, during installation of the dual steering system. As a remedy the following will be performed.

- The supply and delivery tubing between the Right and Left Foot Valves will be changed from 1/2" to 3/8" diameter for the rear brake system.
- The existing Quick Release Valve (QRV) for the front brake system will be replaced with an R-12 Relay Valve with a 1/2" air supply line.
- The rear brake QRV will be relocated forward to inside the right frame rail adjacent to the rear engine cross member. The 1/2" air line between the Brake Foot Valves, QRV and rear Brake Relay Valve will be changed to a 3/8" air line.
- The 90° fittings will be replaced with straight fittings in the delivery tubing between the Foot Valves for both front and rear brake systems.
- Rear service brake hoses with 45° fittings will be installed.

Owners of the involved vehicles will be notified by mail and instructed to schedule an appointment with an authorized UD Truck Dealer to have this Safety Recall performed at no charge.

## ADMINISTRATION / DEALER RESPONSIBILITY

Dealers are requested to proceed immediately to make the necessary repair to the affected vehicles in inventory.

**It is a violation of federal law for a dealer to deliver a new or used motor vehicle covered by a recall notice until the recall remedy has been performed.**

Owners of affected vehicles will receive an "Authorization for Recall Notification Service" card. This postage pre-paid card must be filled out correctly and returned to the address on the card indicating whether the vehicle was repaired, transferred, sold, etc. (refer to the UD Warranty Policies & Procedures Manual, Part III, Section 1). For vehicles without an "Authorization for Recall Service" card, check the vehicle identification number with the Vehicle Service Notification screen of the NDAINET Warranty Claim System menu.

**Federal regulations require that all vehicle lessors must notify all lessees within ten (10) days of receiving this notice.**

## SERVICE INFORMATION

***Before servicing the vehicle, read the entire set of instructions first. Observe the following safety precautions to prevent personal injury, damage to property, or both:***

- If the involved vehicle has a label on the inside of the driver's left door as shown in Figure A, the recall has already been performed and no further action is required.
- If the involved vehicle does not have the label on the inside of the driver's door, verify through the Vehicle Service Notification screen of the NDAINET system that the recall is required. Complete the safety recall according to the following instructions.
- Park the vehicle on a flat surface, place the transmission in NEUTRAL, set the parking brake and chock the rear wheels.

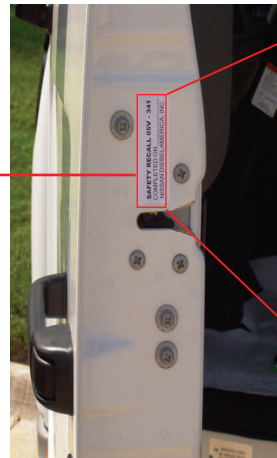

Figure A

SAFETY RECALL 09V-487  
COMPLETED ON  
NISSAN DIESEL AMERICA, INC.

## PARTS INFORMATION

Repair parts are available through normal UD Truck repair parts procedures.

Description	Part Number	Quantity
Brake Kit*	330009V487	1

Brake Kit\* part number 330009V487 has several fittings that are packaged by component and identified for easy installation to each component. **Detailed Parts List - [Click Here](#)**

## SERVICE PROCEDURE (CONT.)

**Step 1)** Drain air from the air tanks.

**Step 2)** Remove the cab splash guards to gain access to the RT and LFT side brake foot valves.

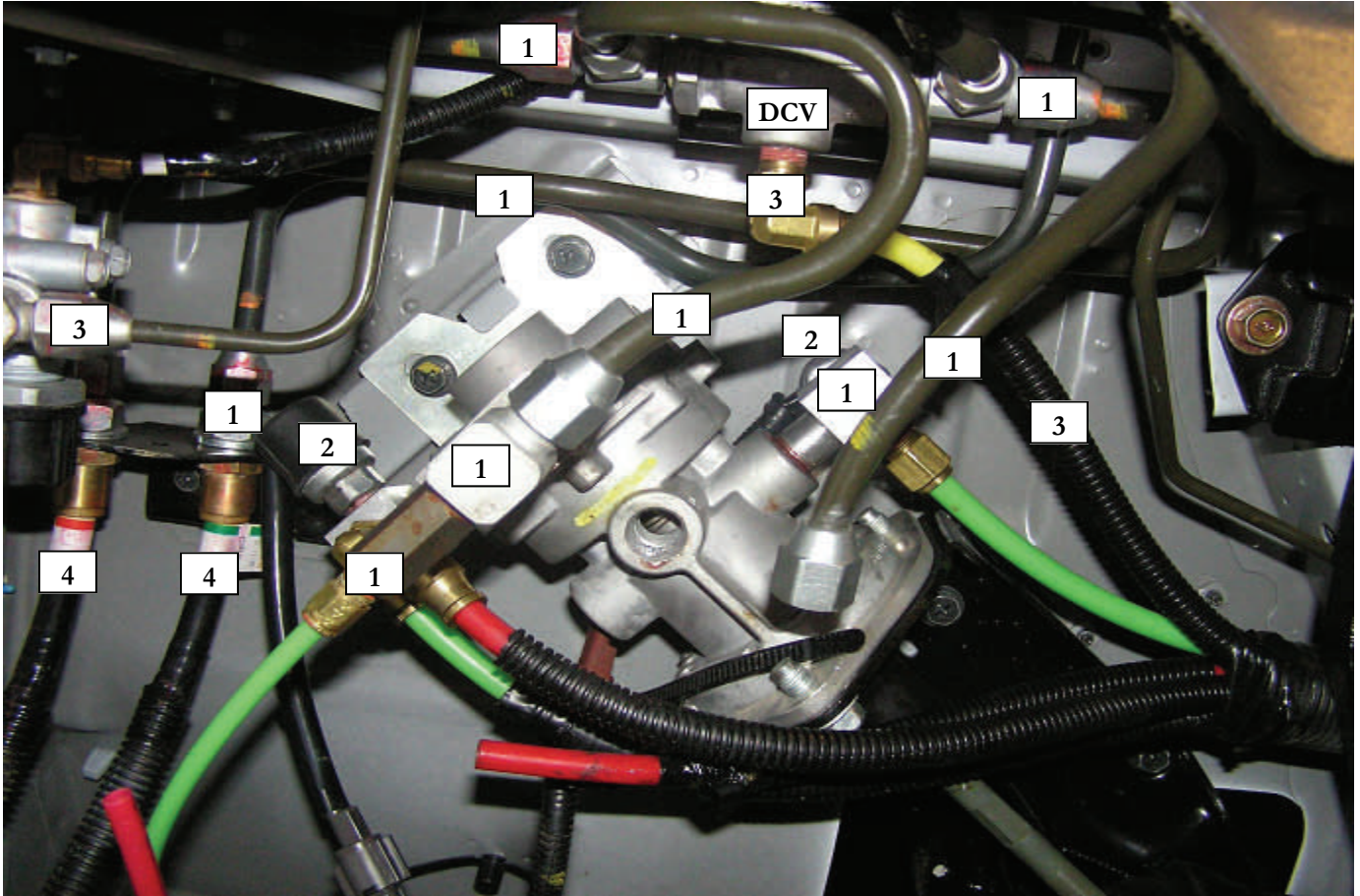

**Figure B - LH Foot Valve**

- 1 Remove all steel lines and fittings from the LH foot valve and discard.
- 2 Remove brake light switches and save for later use.
- 3 Do Not remove the steel line for the air seat and one fitting from the double check valve (DCV) and its air line.
- 4 Remove the main air hoses from the fittings and remove and discard the bracket.

**DO NOT REMOVE THE FOOT VALVE**

**Step 3)** Remove all of the fittings, steel air lines and brake switches from the LFT side foot valve and park brake double check valve as shown in 1 ~ 4 above.

## SERVICE PROCEDURE (CONT.)

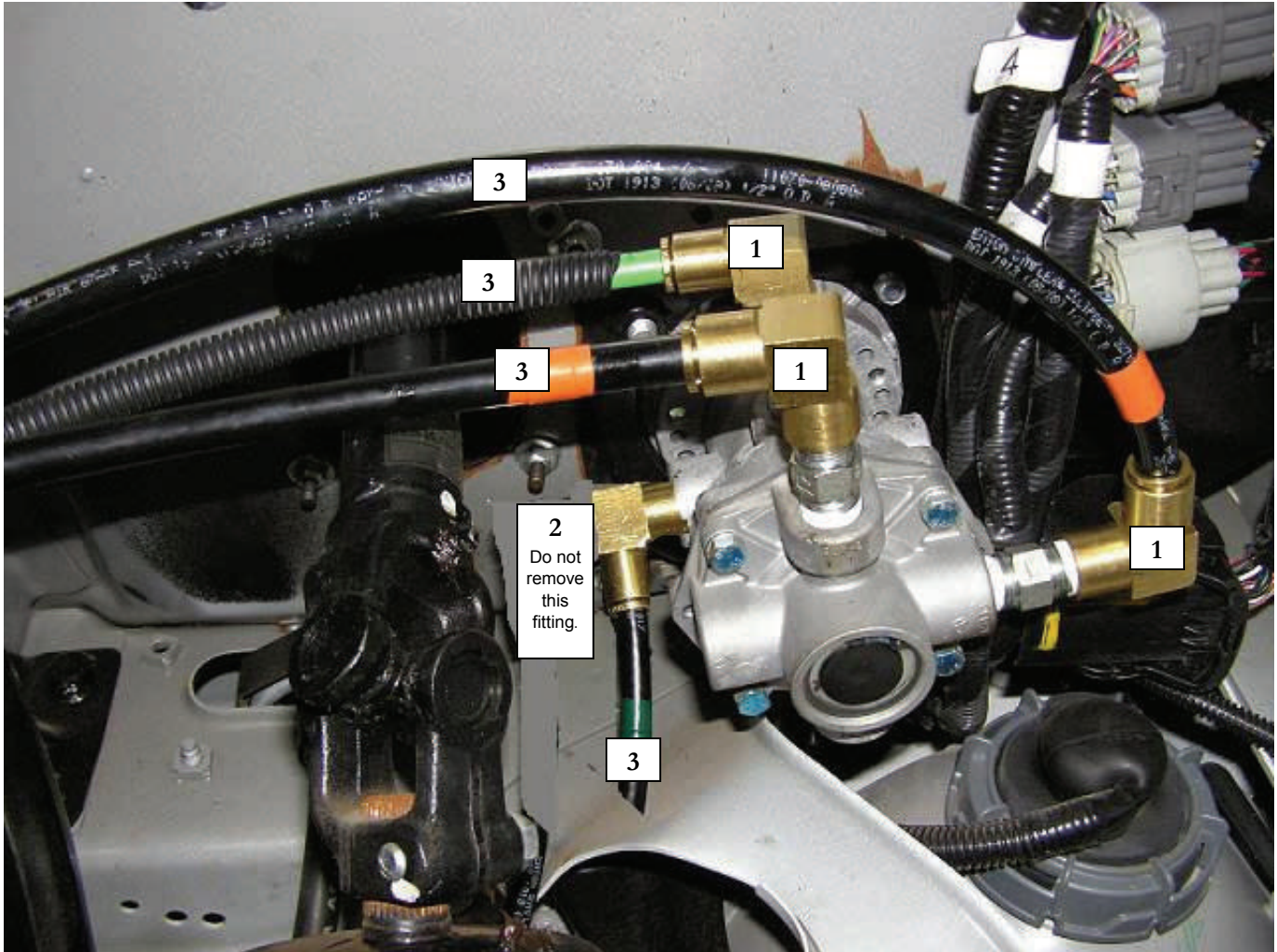

**Figure C - RH Foot Valve**

- 1 Remove 3 fittings from the RH foot valve.
- 2 Do Not remove the fitting closest to the steering shaft.
- 3 Remove all existing plastic air lines from the RH foot valve and discard.

**DO NOT REMOVE THE FOOT VALVE**

**Step 4)** Remove 3 of the fittings and all air lines from the RT side foot valve as shown in 1 ~ 3 above.

## SERVICE PROCEDURE (CONT.)

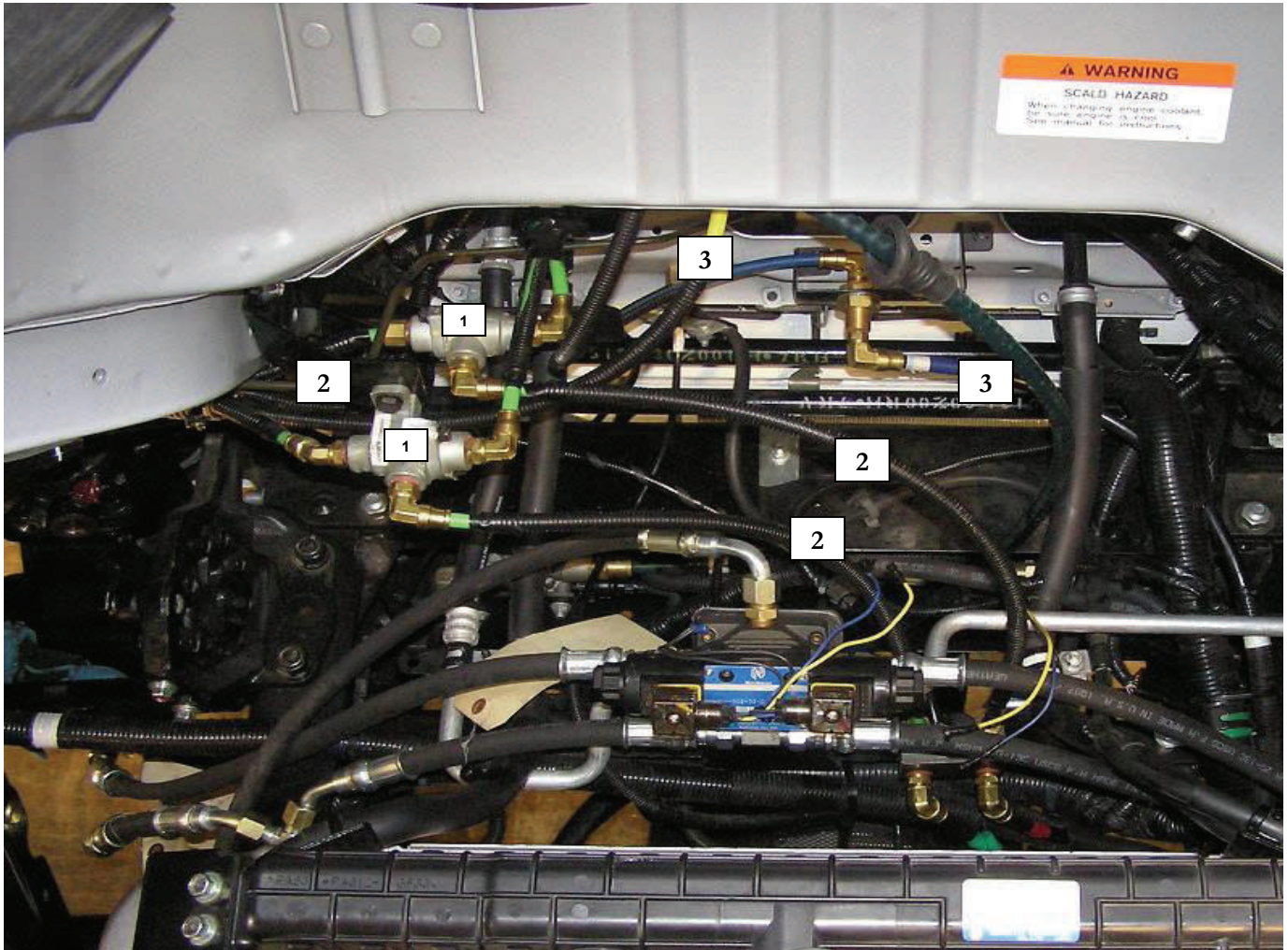

Figure D

### DCV's & air lines

- 1 Remove 2 double check valves (DCV) and discard.
- 2 Remove the air lines and DCV mounting bracket and discard.
- 3 Do Not remove the air lines that enter the cab or air lines that are not connected to the DCV's.

**Step 5)** Remove the double check valves, mounting bracket and air lines to these valves as shown in 1 ~ 3 above.

## SERVICE PROCEDURE (CONT.)



**Figure E**

### **Aluminum switch block, brake light switch & air lines**

- 1** The aluminum switch block is located under the power steering hoses.
  - Remove the air lines from the aluminum switch block.
  - Remove the aluminum switch block.
  - Remove the brake light switch from the switch block, save switch for reuse and discard aluminum block.
- 2** This 1/2" air line will be used to connect to the new R12 valve as shown in Figure G.

**Step 6)** Remove the aluminum switch block and brake light switch as shown in 1 & 2 above.

## SERVICE PROCEDURE (CONT.)

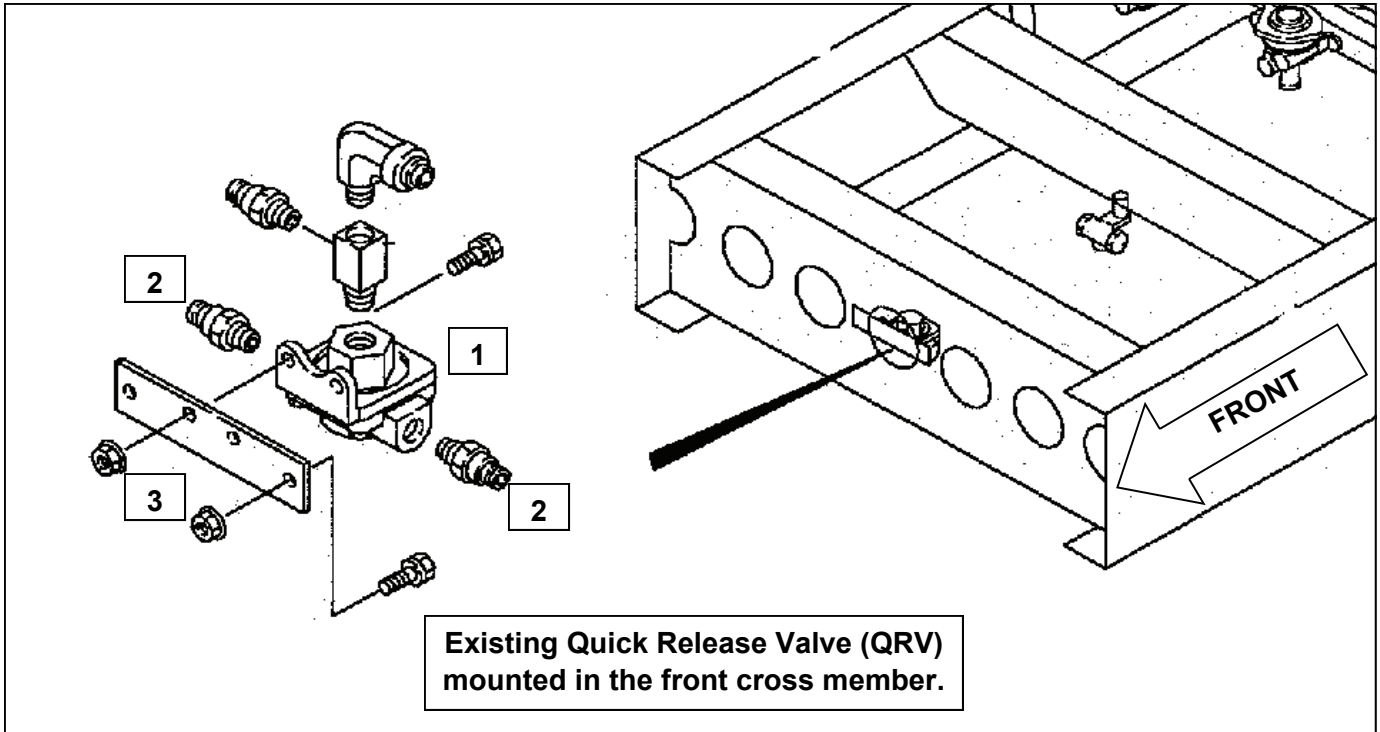

1 Existing QRV mounted in the front cross member.

2 Carefully remove the ABS modulator air lines from the QRV. Do not remove the air lines from the modulators. The air lines will be reconnected to the new R-12 valve.

3 Remove the 2 bolts that attach the QRV mounting bracket to the front cross member. Remove the valve from the bracket and discard the QRV.

Figure F

**Step 7)** Remove the Quick Release Valve (QRV) from the front cross member as shown in 1 ~ 3 above.

## SERVICE PROCEDURE (CONT.)

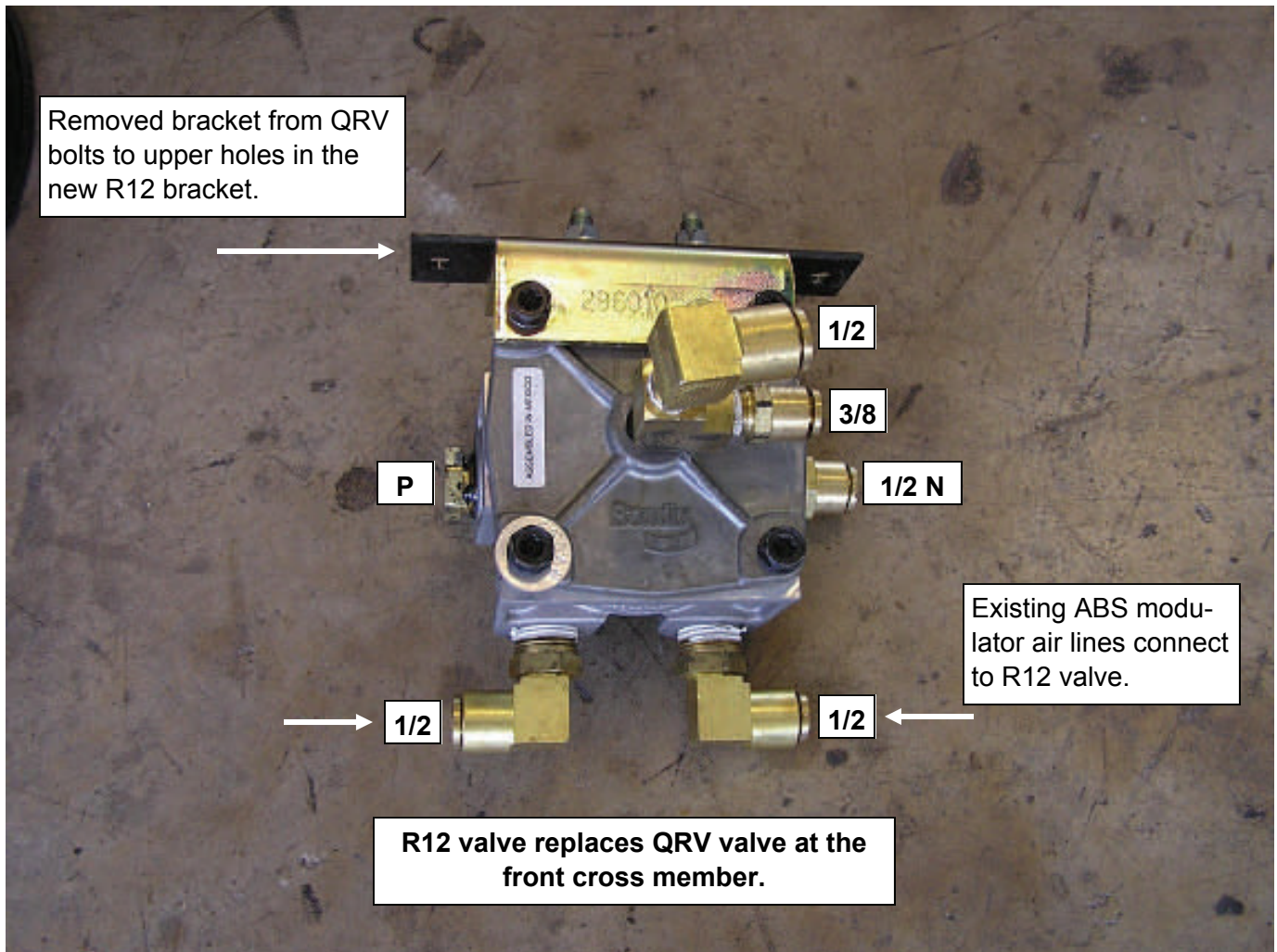

Figure G

Install the new fittings in the R12 valve as shown.

**3/8** 3/8" air line fitting.

**1/2** 1/2" air line fitting.

**1/2 N** A new 1/2" air supply line will be installed at this location.

**P** Install furnished pipe plug.

- Mount the R12 valve to the front cross member using the existing mounting bolts.
- Connect the existing ABS modulator air lines to the R12 valve.

**1/2 N** Connect the 1/2" air line removed from the aluminum switch block in figure E to this location.

**Step 8)** Assemble the new R-12 valve as shown above and install to the front cross member.



## SERVICE PROCEDURE (CONT.)

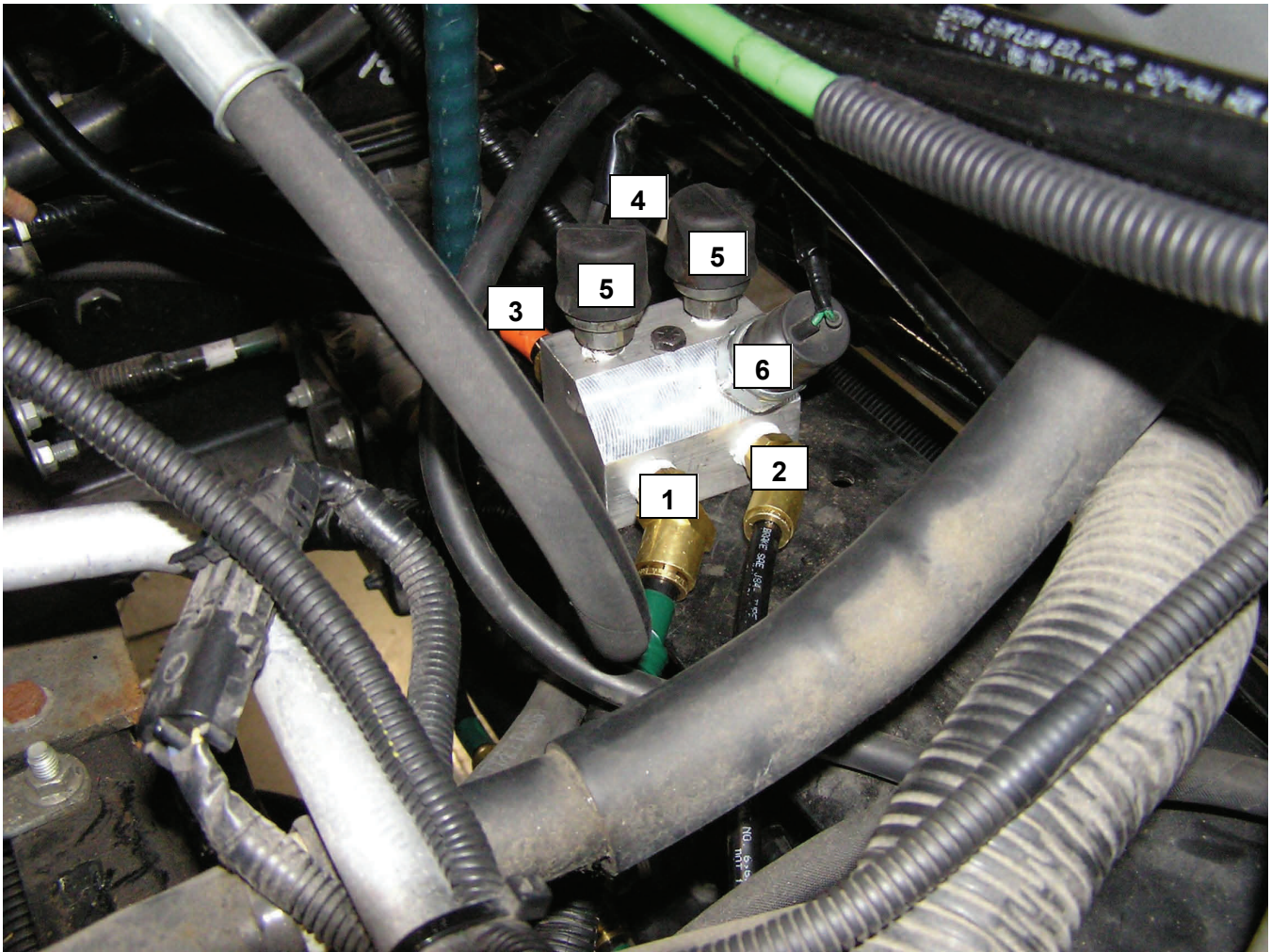

**Figure H**

Install the air line fittings and brake light switches in the aluminum switch block and bolt the switch block to the top of the front cross member as shown.

- 1** 45° fitting for 1/2" air line
- 2** 45° fitting for 3/8" air line
- 3** Straight fitting for 1/2" air line
- 4** Straight fitting for 3/8" air line
- 5** Brake light switch for the front and rear brakes.
- 6** Brake switch to deactivate the cruise control.

**Step 9)** Install the brake light switches and new fittings in the new aluminum switch block and mount as shown in 1 ~ 6 above.

## SERVICE PROCEDURE (CONT.)

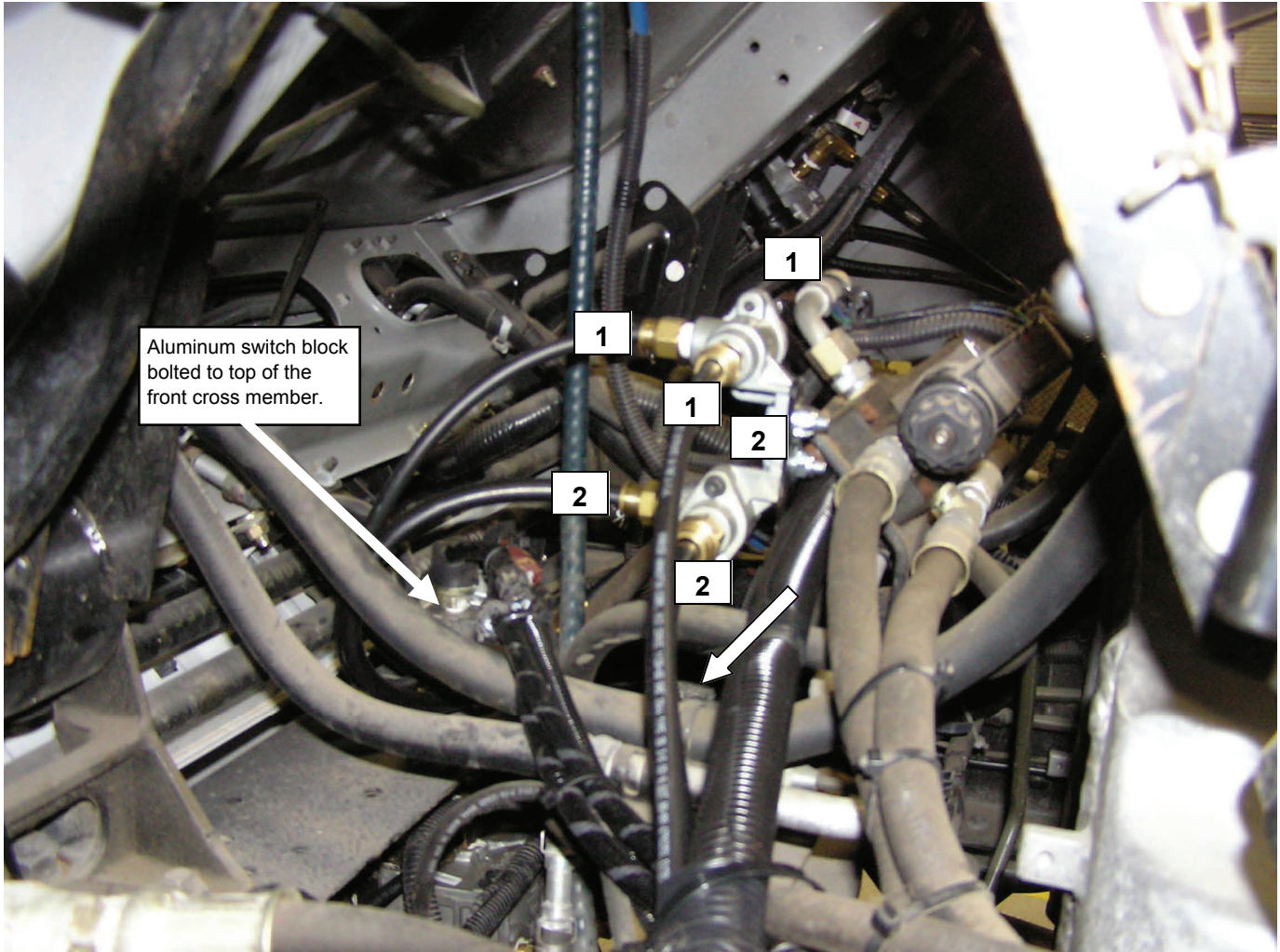
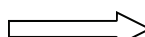

Figure 1

Install the 3/8" air line fittings in one double check valve (DCV) and the 1/2" air line fittings in the other DCV. Install both DCV's to the mounting bracket and bolt the bracket to the heater hose support bracket as shown.

**1** 3/8" air line fittings. Install air line to the aluminum switch block straight fitting as shown.

**2** 1/2" air line fittings. Install air line to the aluminum switch block straight fitting as shown.

 Remove the bolt for the heater hose bracket and attach the DCV bracket.

**Step 10)** Install 2 new double check valves with new fittings to the new mounting bracket as shown above.

## SERVICE PROCEDURE (CONT.)

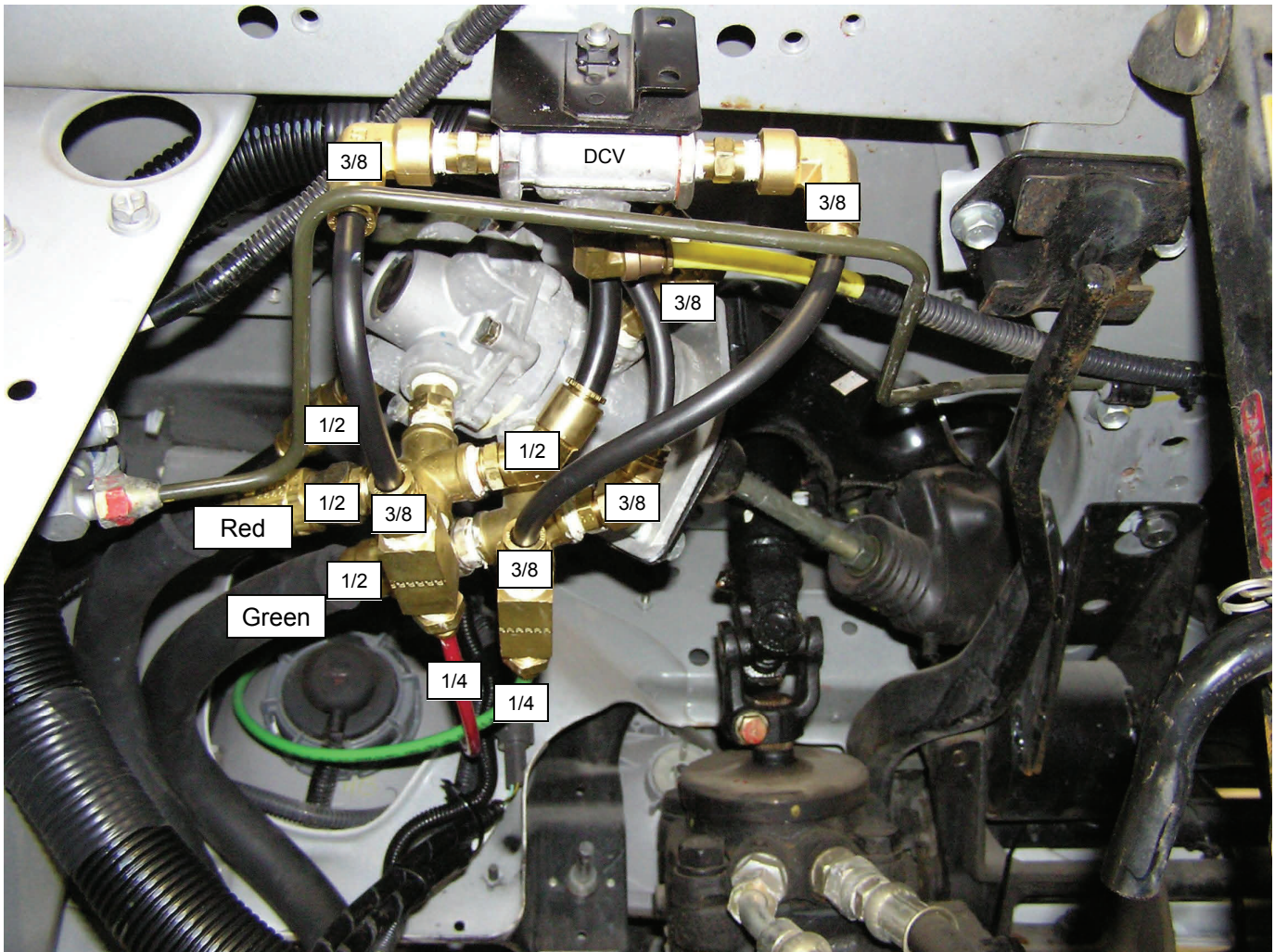

Figure J

### LH foot valve with new air lines and fittings installed.

**CAUTION:** The pipe thread adapter fittings are BSPT on one end and NPT on the other end. BSPT is installed into the foot valves and existing park brake DCV.

**CAUTION:** "T" fittings must be installed as shown to prevent contact when the cab is lowered. After installation verify "No Interference" with cab down.

$\frac{3}{8}$   $\frac{3}{8}$ " air line fittings.

$\frac{1}{2}$   $\frac{1}{2}$ " air line fittings.

$\frac{1}{4}$   $\frac{1}{4}$ " air line fittings.

Green  $\frac{1}{2}$ " Factory air supply line with green stripe. Also see figure B, number 4.

Red  $\frac{1}{2}$ " Factory air supply line with red stripe. Also see figure B, number 4.

**Step 11)** Install the new fittings in the LFT foot valve and park brake DCV as shown above.

## SERVICE PROCEDURE (CONT.)

Install 1 - 3/8" air line fitting with BSPT to NPT adapter.

Install 2 - 1/2" air line fittings with BSPT to NPT adapters.

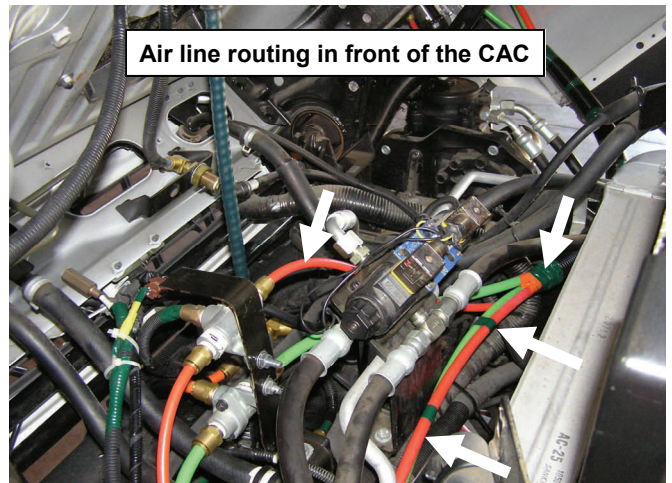
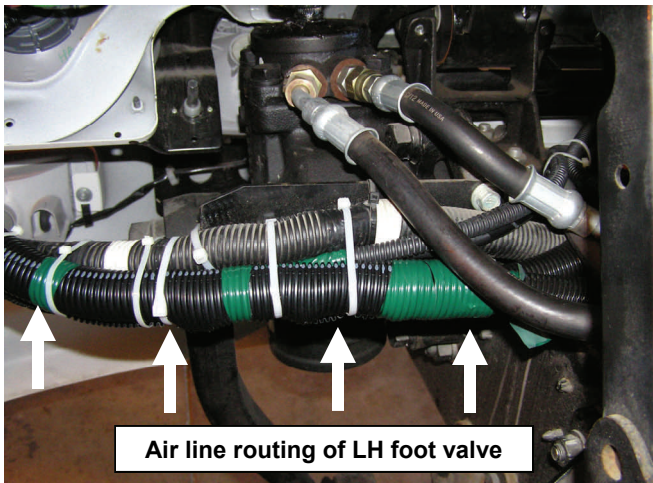
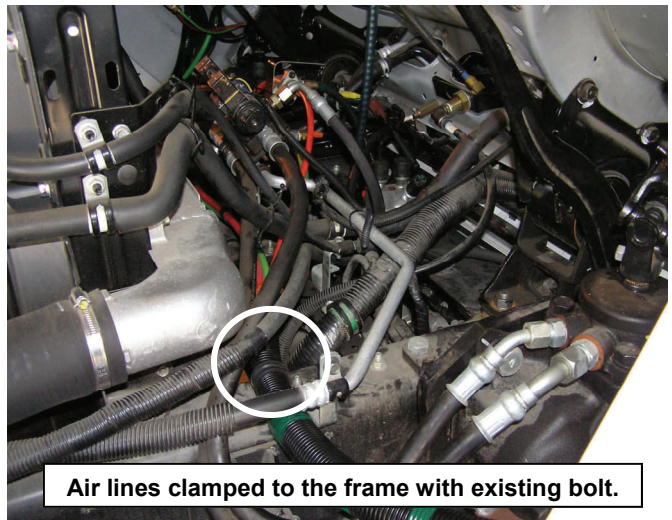
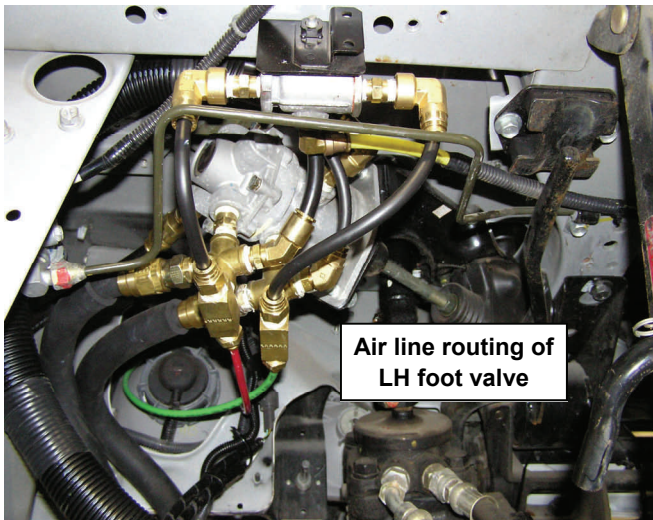
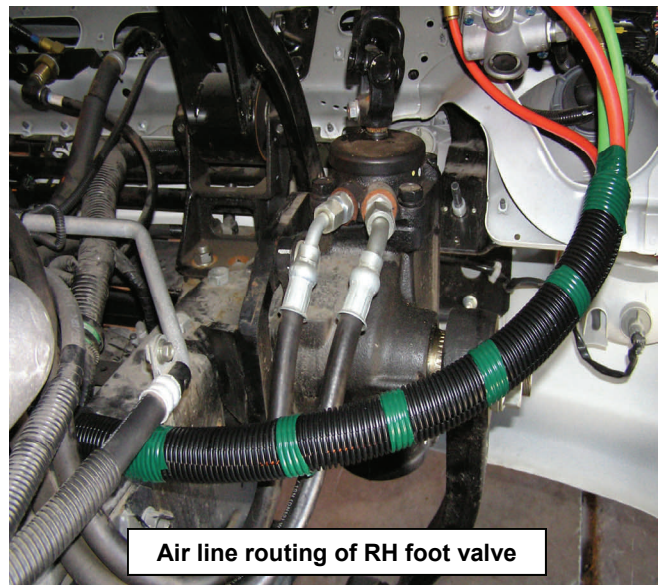
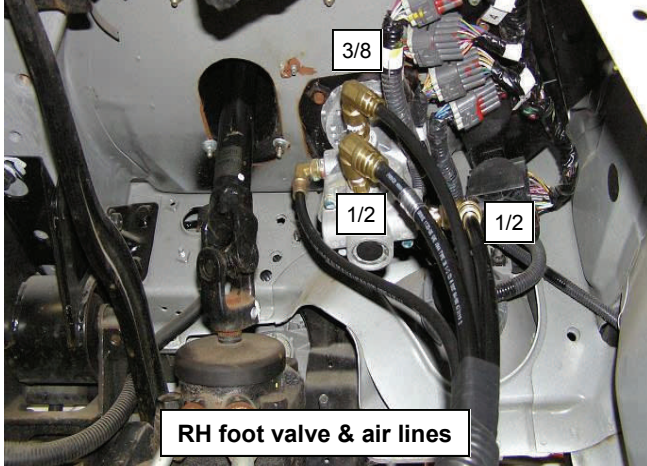

Figure K

**Step 12)** Install new fittings in the RT foot valve as shown in the top left photo.

**Step 13)** Using the photos in figure K and air line diagram figure L, Install new air lines between the LFT and RT foot valves and double check valves.

**UD33RS (Dual Steering)  
Brake Air-Line Diagram**

- ◆ 1/4" air line
- ★ 3/8" air line
- 1/2" air line

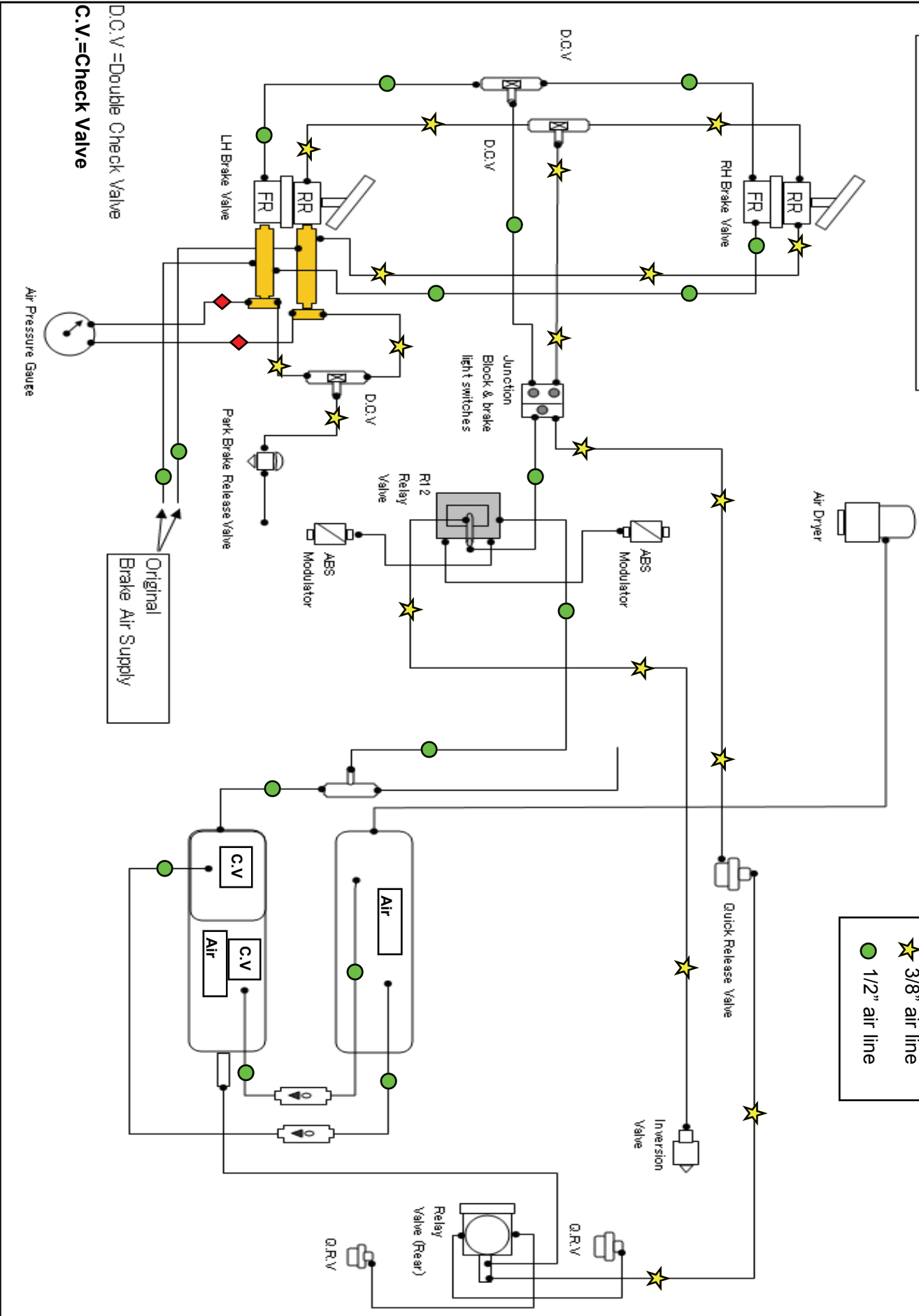

D.C.V.=Double Check Valve  
C.V.=Check Valve

Figure L

## SERVICE PROCEDURE (CONT.)

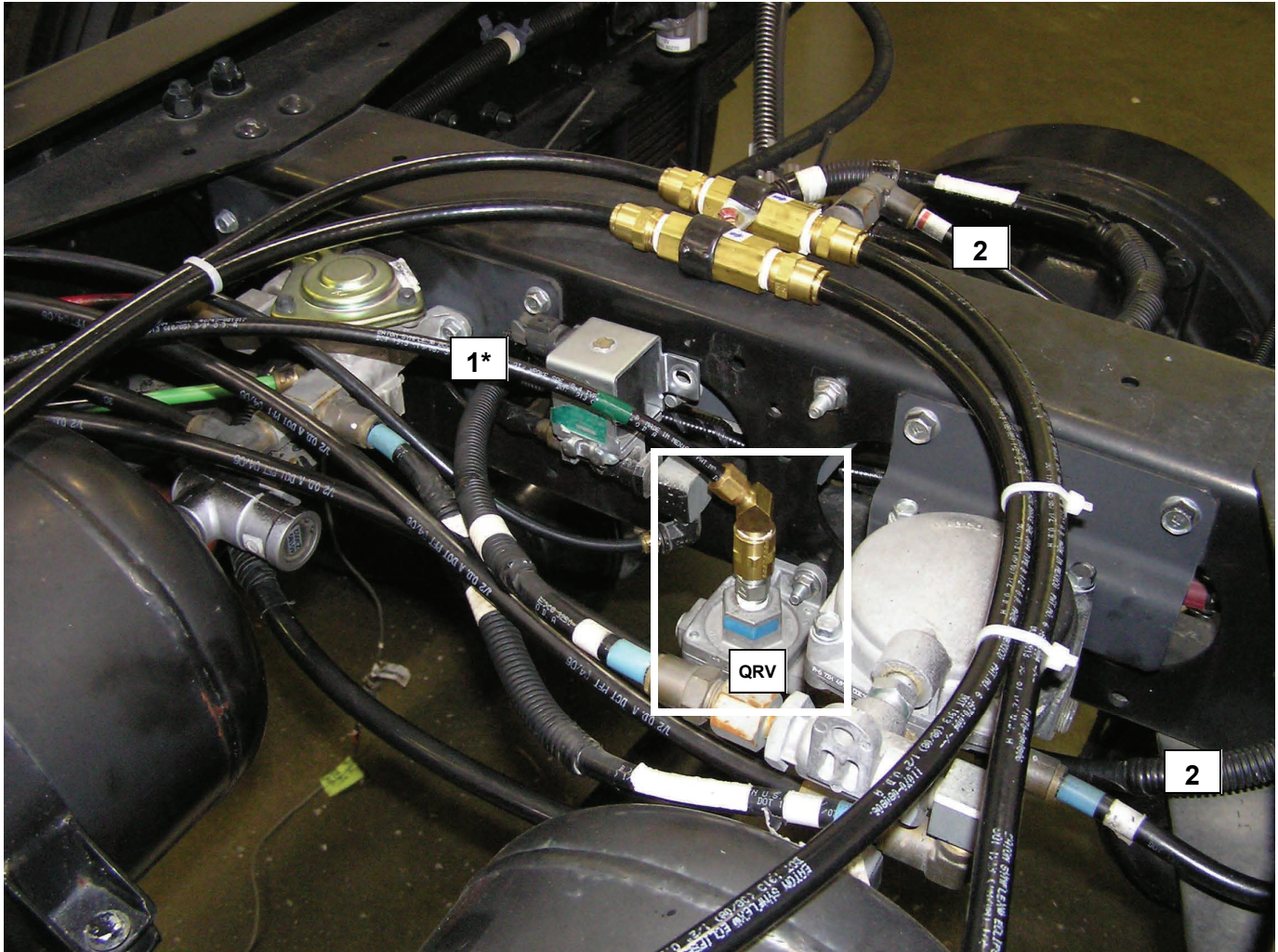

Figure M

- 1\*** Disconnect the 1/2" air line from the rear brake QRV inlet.  
NOTE: The 1/2" air line will be used in step 16, figure O.
- 2** Remove the 1/2" air line from the QRV outlet to the relay valve mounted on the rear side of the cross member.
- QRV** Unbolt the QRV from the cross member, change the air line fittings for 3/8" air line and bolt the QRV inside the RT frame rail near the rear engine mount as shown in **figure N**.

**Step 14)** Disconnect the 1/2" air lines 1 & 2 from the rear brake QRV and relocate the valve as shown in figure N.

**(NOTE) 1\*** Connect the front end of this 1/2" air line to the (1/2 N) fitting located on the R-12 valve as in **figure G**.

## SERVICE PROCEDURE (CONT.)



**QRV** Relocated rear brake QRV inside the RT frame rail. Install new 90° 3/8" air inlet fitting and straight 3/8" outlet fitting. The QRV bolts to the frame with one attaching bolt in existing hole. Install a new 3/8" air line from the aluminum switch block to the QRV. See figure H, item 2.

**Relay Valve** Replace the 1/2" air line fitting with a 45° 3/8" fitting. Install a new 3/8" air line from the QRV outlet to the relay valve.

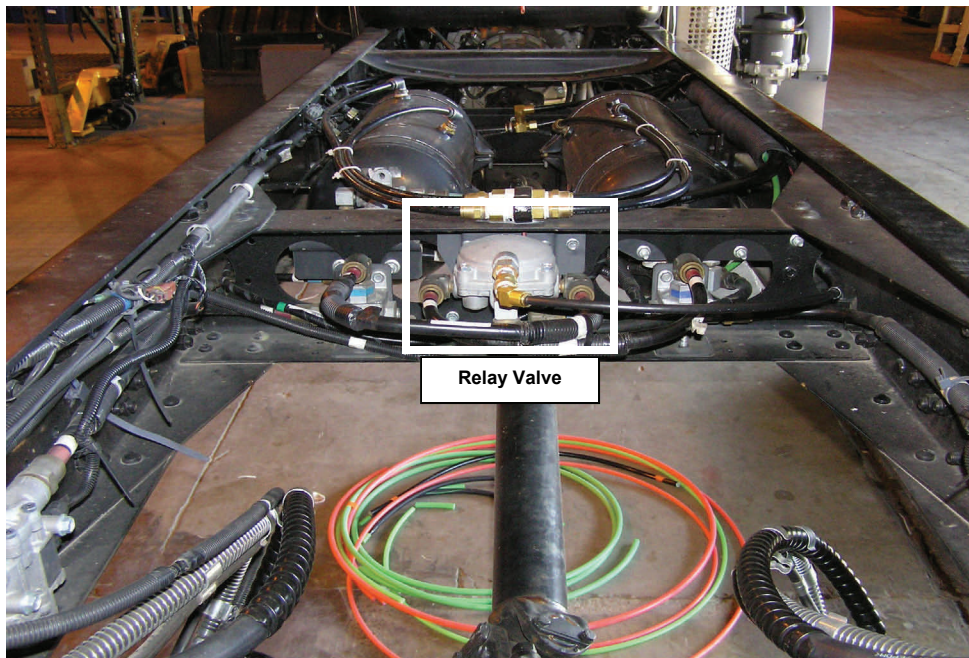

**Figure N**

**Step 15)** Unbolt the QRV from the rear suspension cross member, change the 1/2" air line fittings to 3/8" air line and relocate the QRV to the inside of the RT frame rail near the rear engine mount as shown above.

## SERVICE PROCEDURE (CONT.)

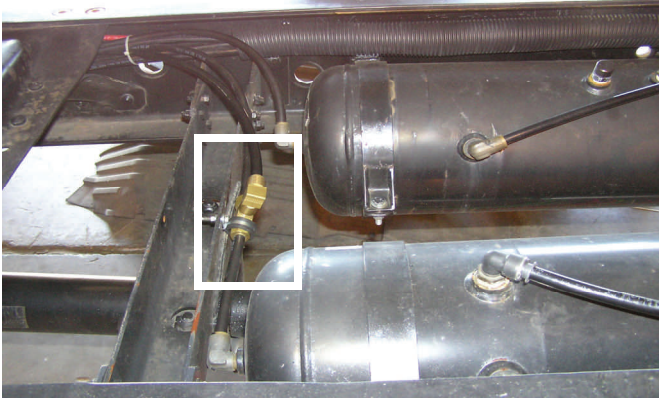

### Step 16)

1. Install the 1/2" air line splice and clamp it to the cross member as shown.
2. Connect the 1/2" air line (removed from the QRV valve in **Step 14, figure M**) to the splice.

#### Air line splice

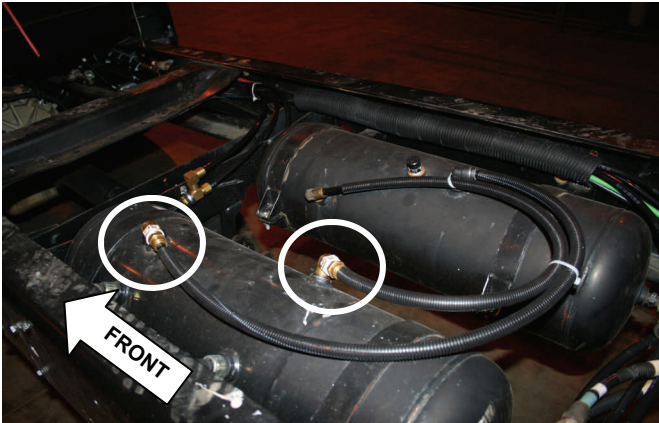

### Step 17)

1. Install 2 -1/2" check valves in the double chamber air tank.
2. Connect the air lines to the check valves.

#### Air tank check valves

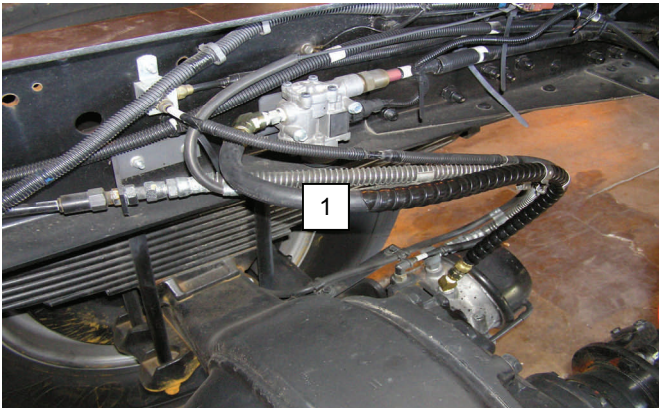

### Step 18)

Installation of new rear service brake hoses from the ABS modulators to the chambers using 45° fittings on both ends as shown.

**NOTE: The hose swivel end attaches to the chamber.**

1. Starting at the hose swivel end, wrap the hoses with the spiral hose wrap prior to installation.
2. Install one 45° fitting with a BSPT adapter in the ABS modulator and one 45° fitting with no adapter into the chamber.
3. Clamp hose to the parking brake hose with the existing clamps positioned over the spiral wrap.

#### Rear service brake hoses

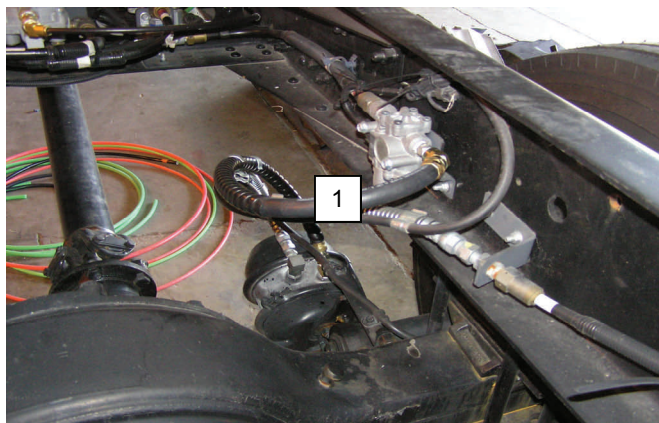

Figure O



## SERVICE PROCEDURE (CONT.)

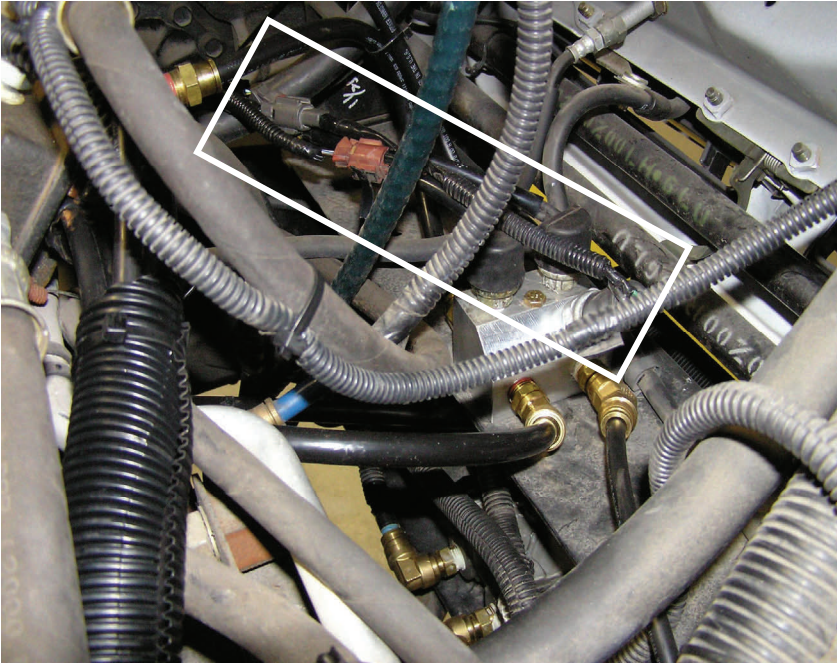

Figure P

### Step 19)

1. Install 2 new harnesses p/n-2402733209 to the brake light switches.

2. Cut the cruise switch harness on the cab side and splice in sufficient wire to connect the harness to the switch. Use heat shrink to seal connections.

### **Brake light switch wiring**

**Step 20)** Lower the cab and verify the fittings on the LH foot valve and all air lines are free of interference. Run the engine and build up the air pressure. Release the parking brake. Check the brake operation from both sides and verify the brake lights operate and no air leaks.

**Step 21)** Record the completion date on the Safety Recall 09V-487 sticker as shown and apply to the driver's left side door as shown in Figure A on page 2.

**SAFETY RECALL 09V-487**  
**COMPLETED ON \_\_\_\_\_**  
**NISSAN DIESEL AMERICA, INC.**

---

## **WARRANTY INFORMATION**

Expenses for the repairs described in this Safety Recall are to be recovered through the standard UD Warranty Claim procedures listed in the UD Warranty Policies & Procedures Manual, Part V. Use the following information to prepare your claims:

<b>WARRANTY CODE</b>	KV04
<b>TROUBLE CODE</b>	77800376
<b>FAILED PART NUMBER/NAME</b>	45151Z0005
<b>REPAIR DESCRIPTION</b>	PERFORM SAFETY RECALL 09V-487
<b>LABOR OPERATION</b>	789X
<b>LABOR TIME ALLOWED</b>	14.0 HR Install 121 brake kit
<b>PARTS DISPOSITION</b>	Dispose of removed parts following local regulations

	A-SERVICE BRAKE HOSES	QTY.
AB 282366-36	1/2 X 36 AB HOSE W/ MP/MPX	2
WHA 3350X6	3/8 45 DEG ST. EL	4
WHA 3300X6	3/8 COUPLING	2
RSG-20L	1/2 SPIRAL WRAP	6 FT
BST-MP-5404-06-06	3/8 MBST X MHPT	2
	B-QR-1 VALVE(RELOCATION)	
BST-MP-5404-06-06	3/8 MBST X MHPT	3
WHA 3300X6	3/8 COUPLING	2
WHA 1880X6X6S	3/8 X 3/8 DOT 45 DEG	1
WHA 1868X6X6	3/8 X 3/8 DOT STR.	1
WHA 1870X6X6S	3/8 X 3/8 DOT 90 DEG FHPT	1
	C-AIR TANK CHECK VALVES	
800376 BENDIX	1/2" CHECK VALVES	2
WHA 1868X8X8	1/2 X 1/2 DOT STR	2
WHA 1862X8	1/2 DOT UNION	1
WHA 1869X8S	1/2 X 3/8 DOT 90 DEG	2
WHA 1872X8S	1/2 X 3/8 BRANCH TEE	1
WHA 1870X8	1/2 X 3/8 DOT 90 DEG FHPT	1
ZSI SPH-16	1" EPDM CLAMP	1
	D-R-12 VALVE	
065125 BENDIX	R-12 VALVE W/1/2" HOLES	1
WHA 1869X8X8S	1/2 X 1/2 DOT 90 DEG	2
WHA 1868X8X8	1/2 X 1/2 DOT STR	1
WHA 3152X8	1/2 HPT PLUG	1
WHA 3750X4	1/4 STR. TEE	1
WHA 1868X6	3/8 X 1/4 DOT STR	1
WHA 1869X8X4S	1/2 X 1/4 DOT 90 DEG	1
	E-LH FOOT VALVE	
WHA 3950X6	3/8 CROSS	2
WHA 3600X6	3/8 BRANCH TEE	2
BST-MP-5404-04-04	1/4 X 1/4 MBST X MHPT	2
BST-MP-5404-06-06	3/8 X 3/8 MBST X MHPT	4
WHA 1868X4X6	1/4 X 3/8 DOT STR	2
WHA 1868X6X6	3/8 X 3/8 DOT STR	2
WHA 1870X6	3/8 X 1/4 DOT 90 DEG FHPT	2
WHA 1868X8	1/2 X 3/8 DOT STR	2
WHA 1866X8	1/2 X 3/8 DOT STR FHPT	1
WHA 1880X8S	1/2 X 3/8 DOT 45 DEG	1
WHA 1880X6X6S	3/8 X 3/8 DOT 45 DEG	1
WHA 1870X6X6	3/8 X 3/8 DOT 90 DEG FHPT	1

	F-DOUBLE CHECK VALVE	
278614H BENDIX	3/8" DOUBLE CHECK VALVE	2
BRACKET	DOUBLE CHECK VALVE	1
WHA 1868X8	1/2 X 3/8 DOT STR	3
WHA 1868X6X6	3/8 X 3/8 DOT STR	3
	G-SWITCH BLOCK	
SWITCH BLOCK	ALUMINUM SWITCH BLOCK	1
WHA 1868X6X6	3/8 X 3/8 DOT STR	1
WHA 1868X8	1/2 X 3/8 DOT STR	1
WHA 1880X8S	1/2 X 3/8 DOT 45 DEG	1
WHA 1880X6X6S	3/8 X 3/8 DOT 45 DEG	1
2402733209	BRAKE SWITCH HARNESS	2
	H-RH FOOT VALVE	
BST-MP-5404-06-06	3/8 X 3/8 MBST X MHPT	3
WHA 1870X8	1/2 X 3/8 DOT 90 DEG FHPT	2
WHA 1870X6X6	3/8 X 3/8 DOT 90 DEG FHPT	1
	I-PLASTIC TUBING, TAPE, WRAP	
WHG HT10006BK	3/8 DOT TUBING	50 FT
WHG HT10008BK	1/2 DOT TUBING	60 FT
ZSI SPH-24	1 1/2 EPDM CLAMP	2
LM424	1 1/2 SPLIT LOOM	4 FT
LM412	1/2 SPLIT LOOM	12 FT
AL-11-50-0-C	11" BLACK TIE WRAPS	1 BAG
MIS ELECTRICAL	3/4 X 60 FT ELECTRICAL TAPE	1
DIX TTB-50	1/2 X .520 TEFLON TAPE	1